

After they ate, Jesus and Peter had an important conversation.

To find out what they said, change each consonant to the next consonant in the alphabet but leave vowels as they are (vowels are A, E, I, O, U). For example, change B to C, C to D, etc. Change Z to B.

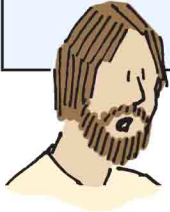

S  
RILOM, ROM OD  
HOGM, CO XOU KOTE  
LE LOQE SGAM SGERE?

XOU JMOV SGAS  
I KOTE XOU.



DEEC LX RGEEN.

# Jesus by the Sea of Tiberias

Jesus appeared to His disciples when they were fishing, but because He stood on the shore, they couldn't recognize Him. Jesus called out to them. What did He ask?

Follow the correct path through the maze to find the letters to fill in the blanks.

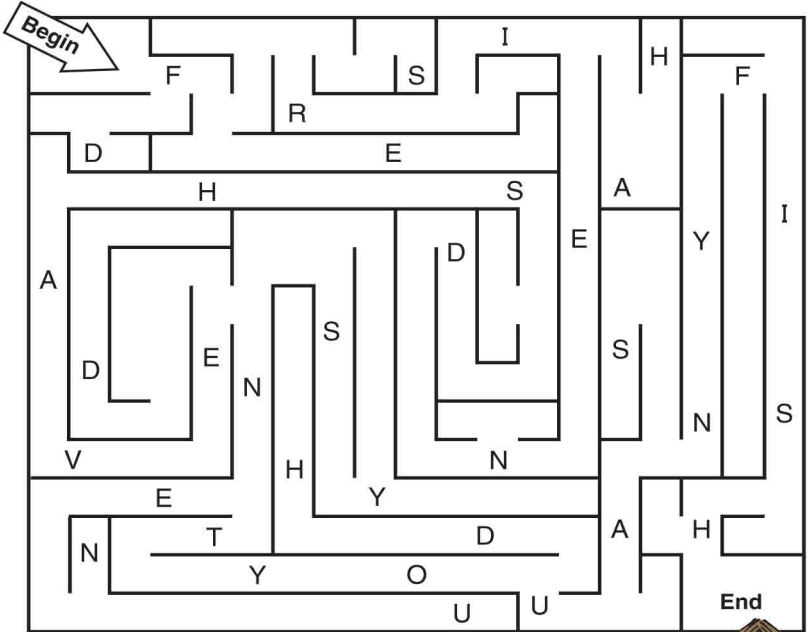

“ \_\_\_\_\_ , \_\_\_\_\_ , \_\_\_\_\_ ?”

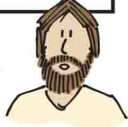

## Welcome to Grace Covenant!

Enter your **SECRET CODE** to unlock games @ [games.childrensbulletins.com](http://games.childrensbulletins.com)

**SECRET CODE!**  
**FANS83**

Jesus called out from the shore, “Throw your net on the right side of the boat.” When they did, the disciples caught so many fish they couldn’t haul the net in!

How many fish did they catch?  
Follow the directions below to find out.

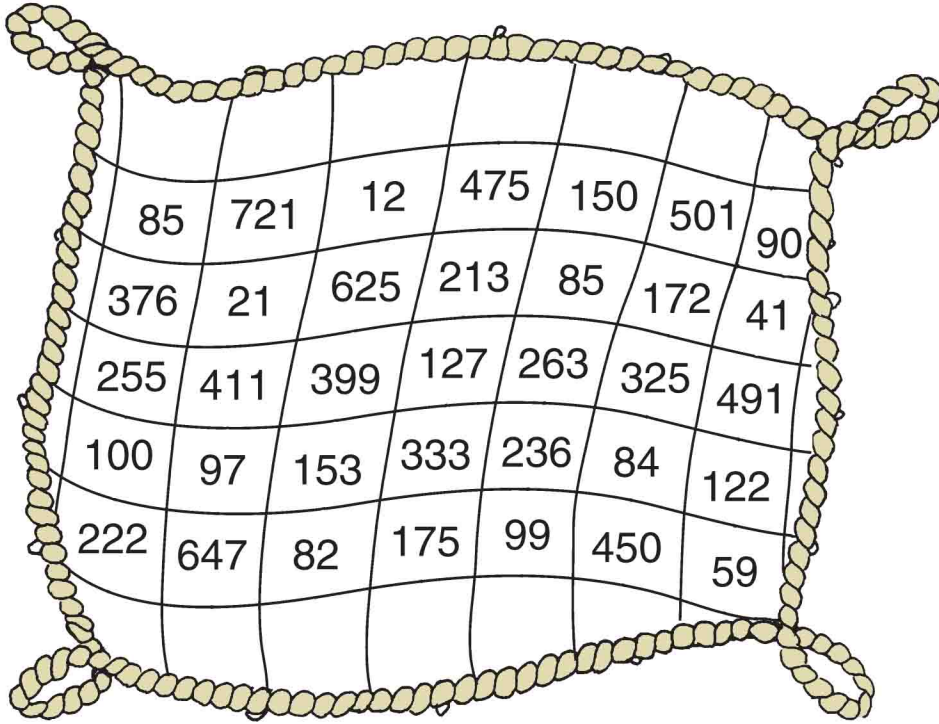

1. Cross out all 2-digit numbers
2. Cross out all of the numbers in the middle row and in the middle column
3. Cross out all even numbers
4. Cross out any number greater than 500
5. You will know you have the right answer if there is only one number left.

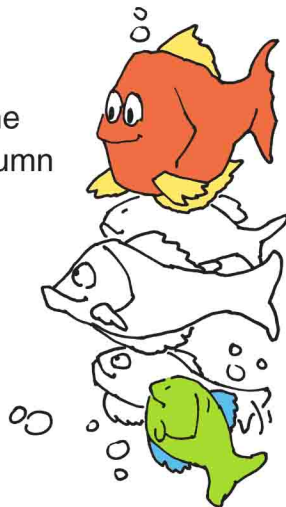

The disciples realized it was Jesus and turned toward the shore to join Him. What did Simon Peter do when he realized it was Jesus?

In order, first write out all the 1's, then all the 2's, then all the 3's and then all the 4's. Fill in the blanks below.

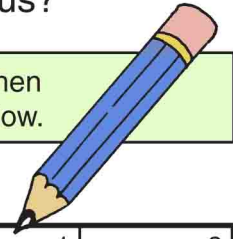

As <sup>1</sup>	him <sup>2</sup>	he <sup>3</sup>	him <sup>4</sup>	soon <sup>1</sup>	say <sup>2</sup>
wrapped <sup>3</sup>	and <sup>4</sup>	as <sup>1</sup>	It <sup>2</sup>	his <sup>3</sup>	jumped <sup>4</sup>
Simon <sup>1</sup>	is <sup>2</sup>	outer <sup>3</sup>	into <sup>4</sup>	Peter <sup>1</sup>	the <sup>2</sup>
garment <sup>3</sup>	the <sup>4</sup>	heard <sup>1</sup>	Lord <sup>2</sup>	around <sup>3</sup>	water <sup>4</sup>



\_\_\_\_\_

\_\_\_\_\_

\_\_\_\_\_

“ \_\_\_\_\_

\_\_\_\_\_”

\_\_\_\_\_

\_\_\_\_\_

\_\_\_\_\_